

## Eco House & Garden Srl

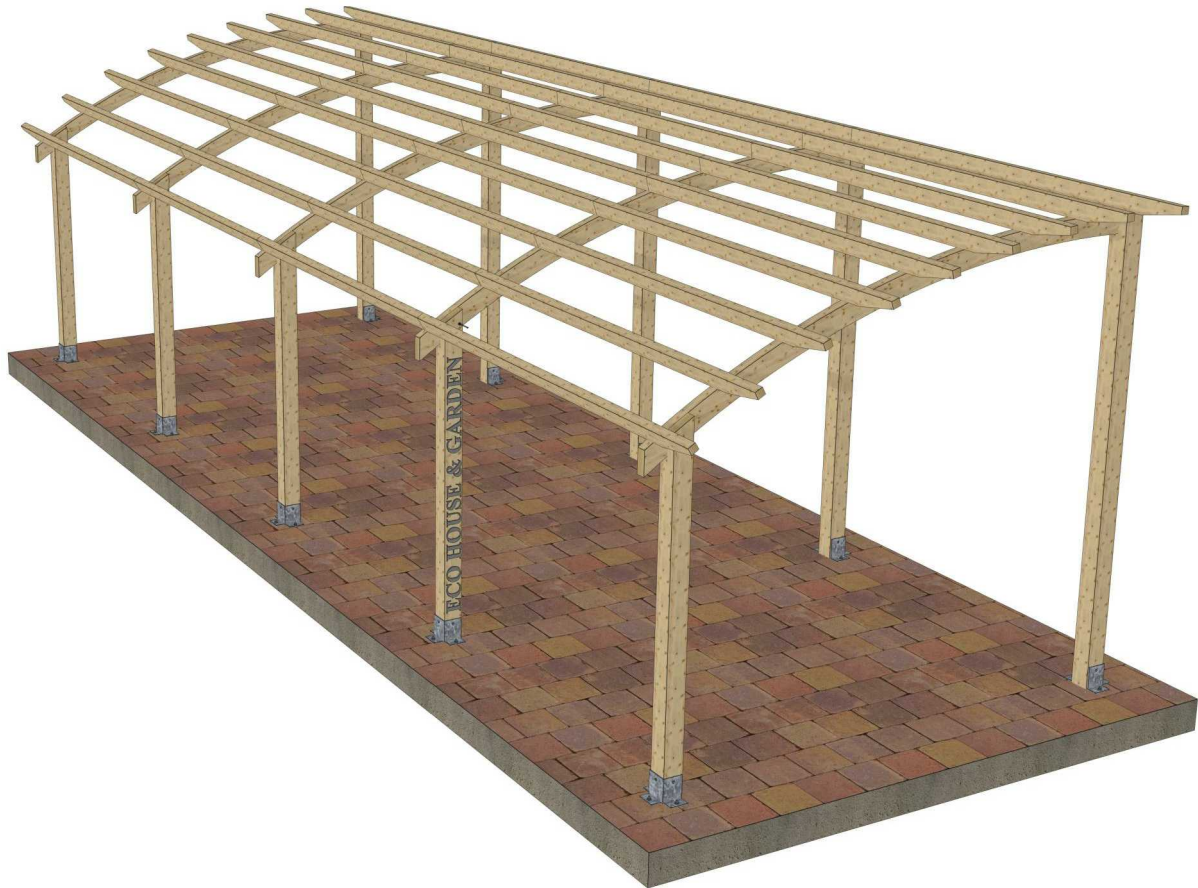

# LEON 2

L = 1050 cm  
W = 348 cm  
H = 300 cm

### Eco House & Garden Srl

Str. Drumul Bercenarului, Nr. 2-4, Sector 4, CP .041116, București

Tel. +40 786 873 196

E-mail: [office@copertine-lemn.ro](mailto:office@copertine-lemn.ro) / [copertinelemn@gmail.com](mailto:copertinelemn@gmail.com)

[www.copertine-lemn.ro](http://www.copertine-lemn.ro)

[www.facebook.com/ecohouse.garden](http://www.facebook.com/ecohouse.garden)

### Vedere transversală

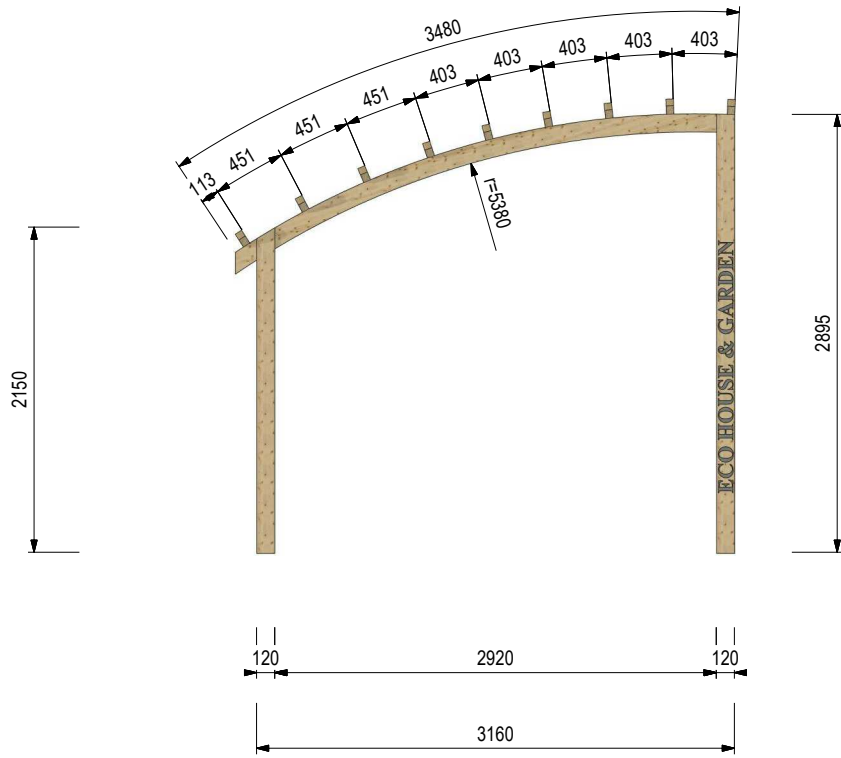

### Vedere axionometrică

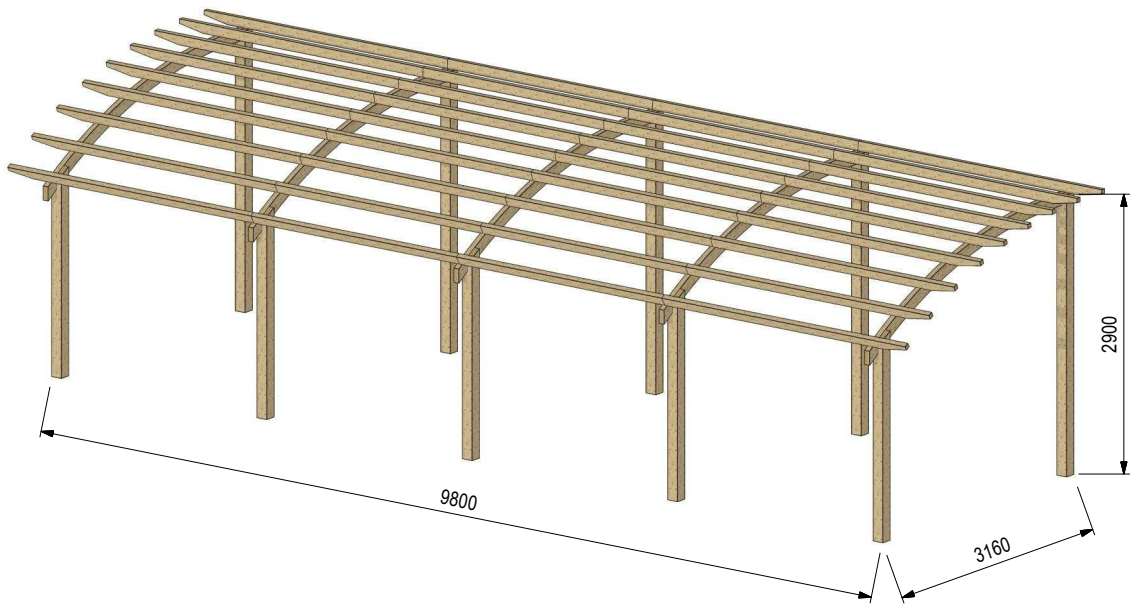

## Vedere longitudinală

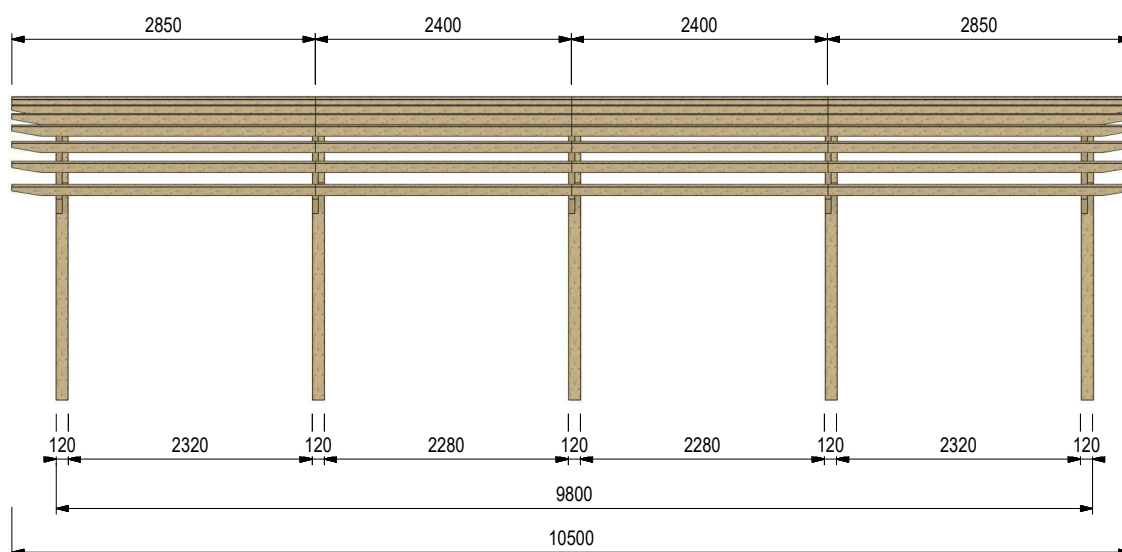

LISTĂ MATERIALE LEON 2		
Nr. Element	Cantitate	Nume
	[buc]	[mm]
1	18	Traversă - 50x100x2850
2	5	Arc Leon - 55x120x3415
3	5	Stâlp - 120x120x2150
4	5	Stâlp - 120x120x2900
5	18	Traversă - 50x100x2400

LISTĂ FERONERIE LEON 2		
Nr. Elemente	Cantitate	Nume
	[buc]	[mm]
6	10	Papuc Metalic
7	30	Conexpand M10
8	30	Holz-Şurub Cap Hexagonal ø8x60
9	20	Holz-Şurub Cap Hexagonal ø8x100
10	72	Holz-Şurub Cap Înecat ø6x160

# Piese

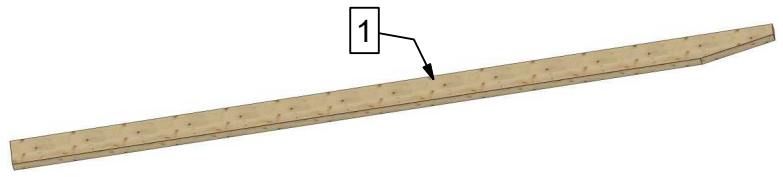

1

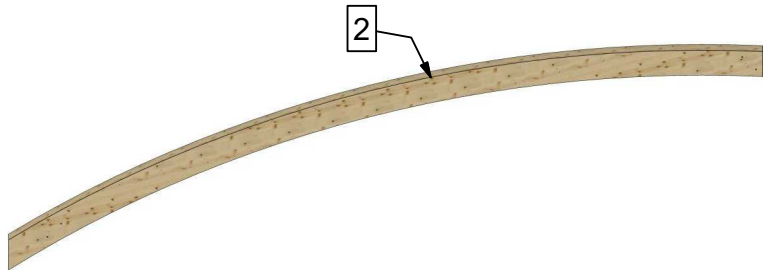

2

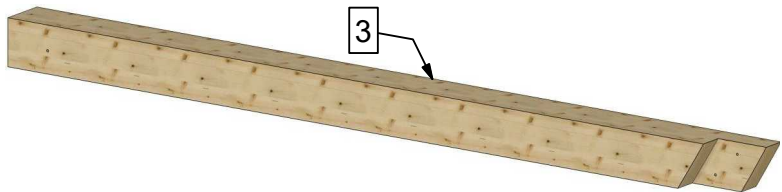

3

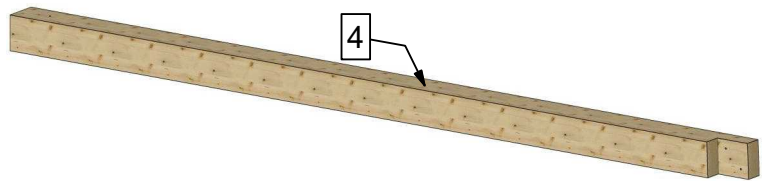

4

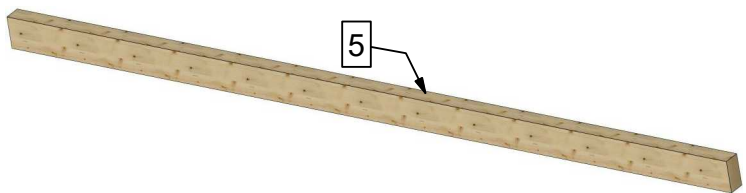

5

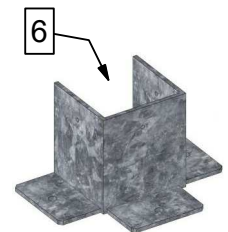
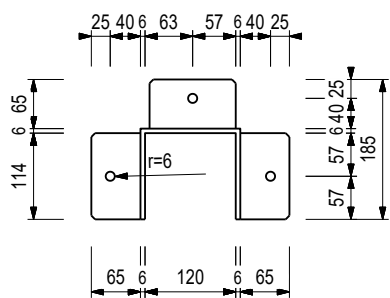
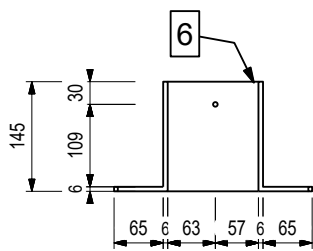

6

## Poziționare stâlpi în fundament cu papucul metalic

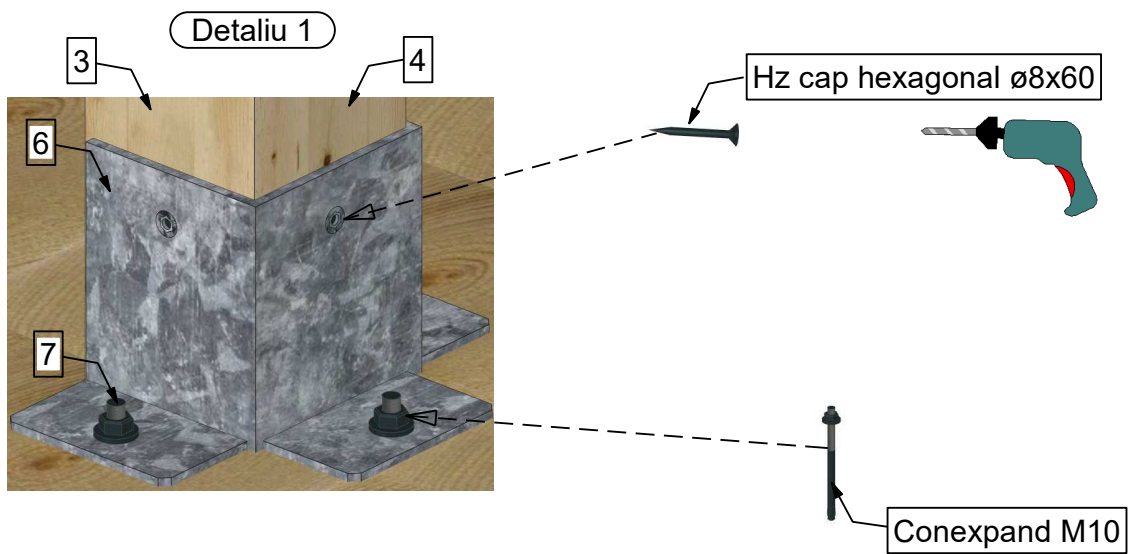
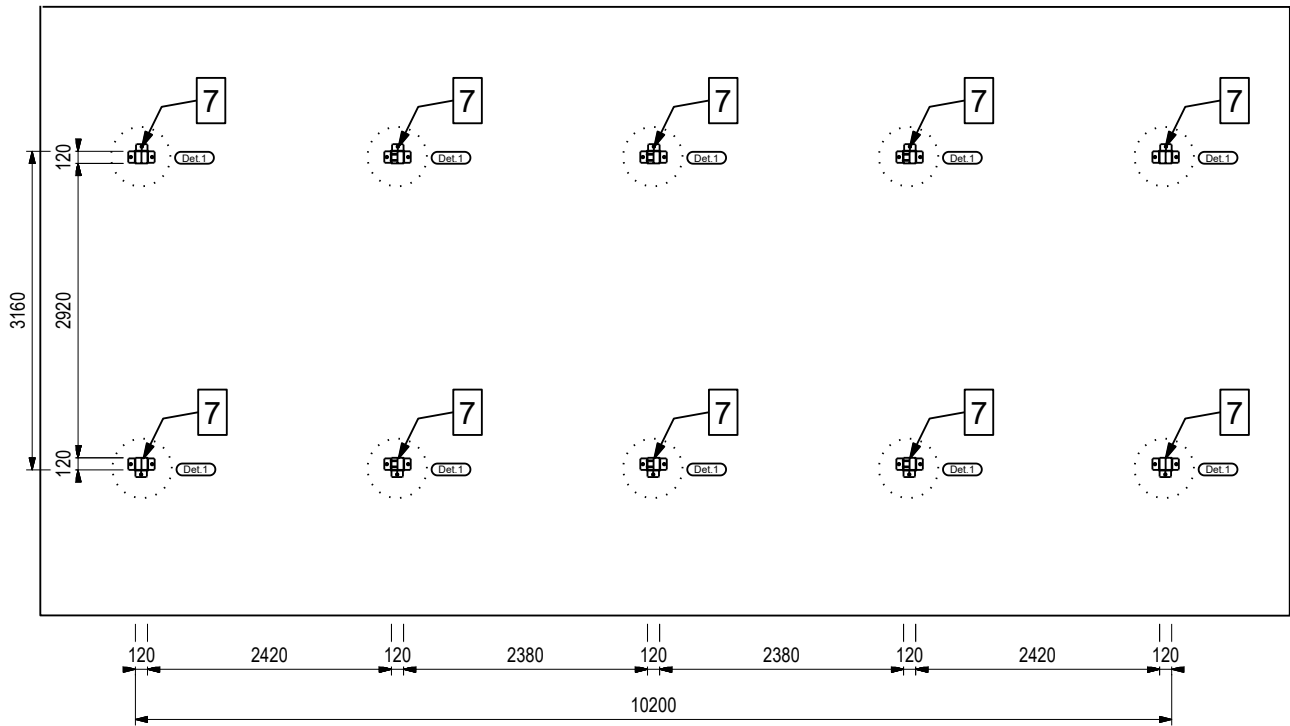

## Poziționare arc Leon în stâlpii 1 și 2

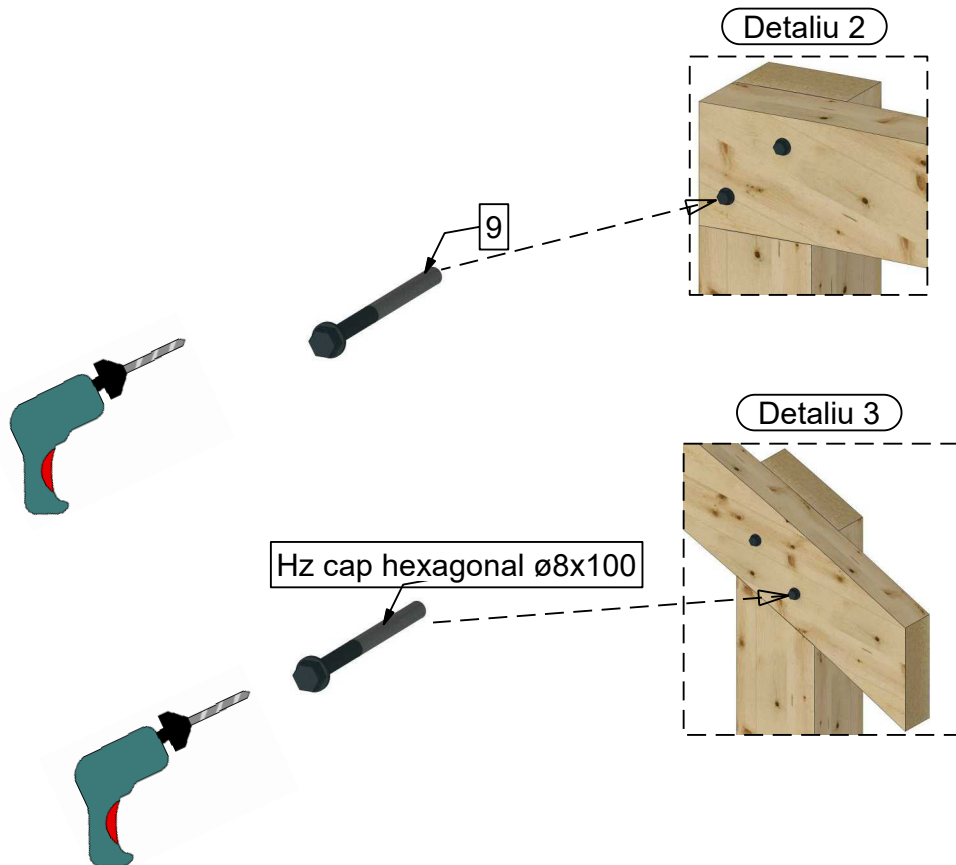

### Poziționare transversă

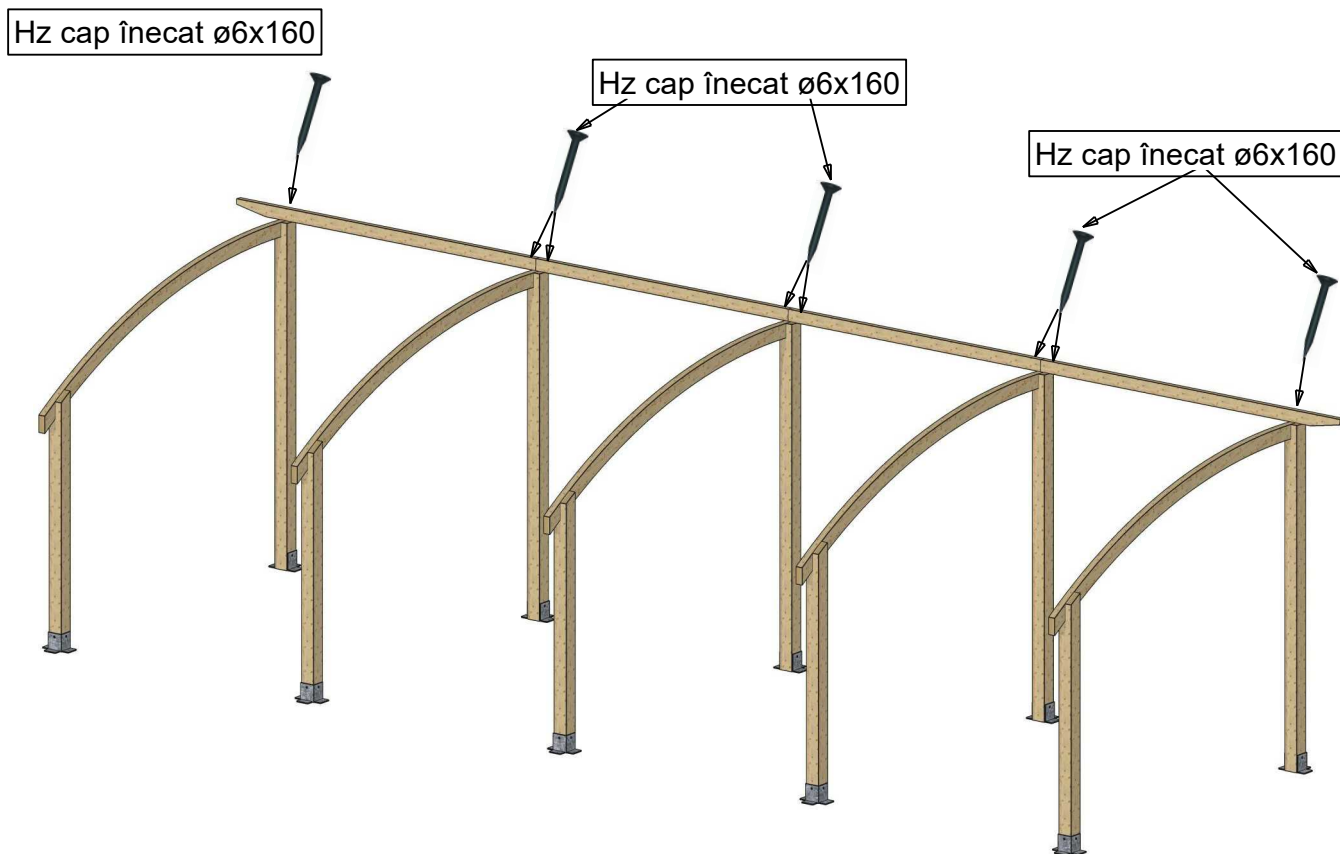

### Axionometrie Leon 2 finală

