

## Eco House & Garden Srl

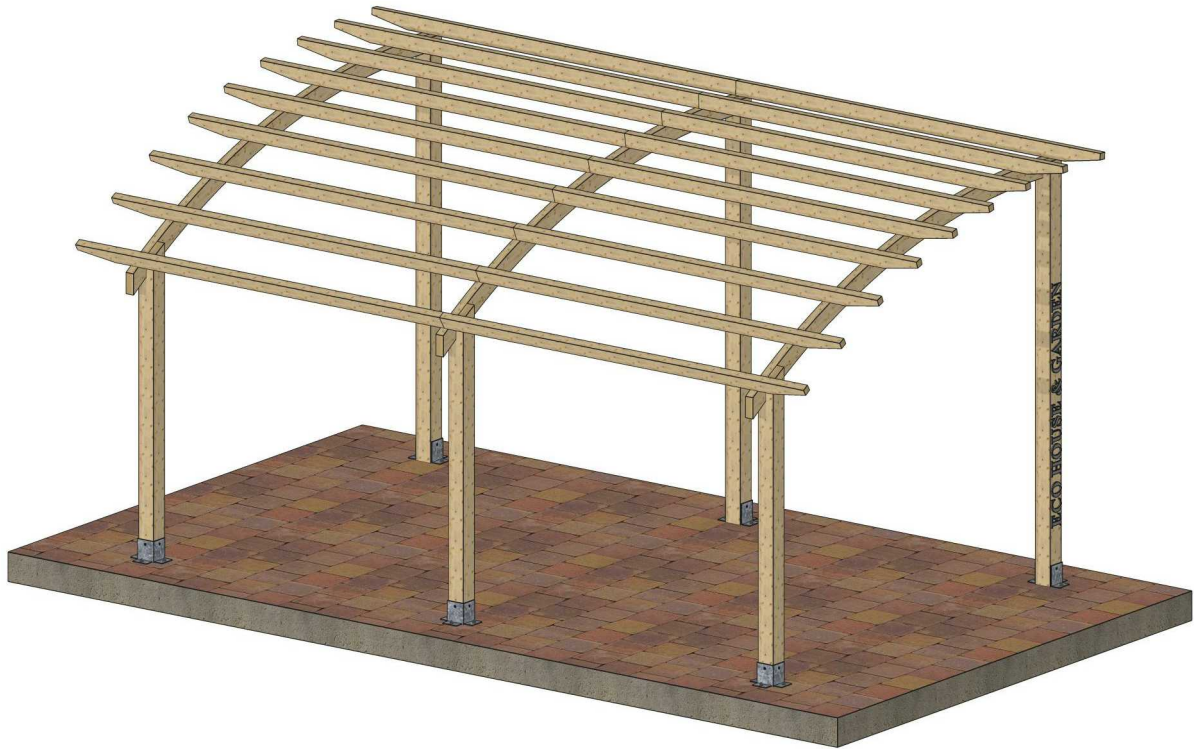

# LEON

L = 597 cm  
W = 348 cm  
H = 300 cm

### Eco House & Garden Srl

Str. Drumul Bercenarului, Nr. 2-4, Sector 4, CP .041116, București

Tel. +40 786 873 196

E-mail: [office@copertine-lemn.ro](mailto:office@copertine-lemn.ro) / [copertinelemn@gmail.com](mailto:copertinelemn@gmail.com)

[www.copertine-lemn.ro](http://www.copertine-lemn.ro)

[www.facebook.com/ecohouse.garden](https://www.facebook.com/ecohouse.garden)

### Vedere transversală

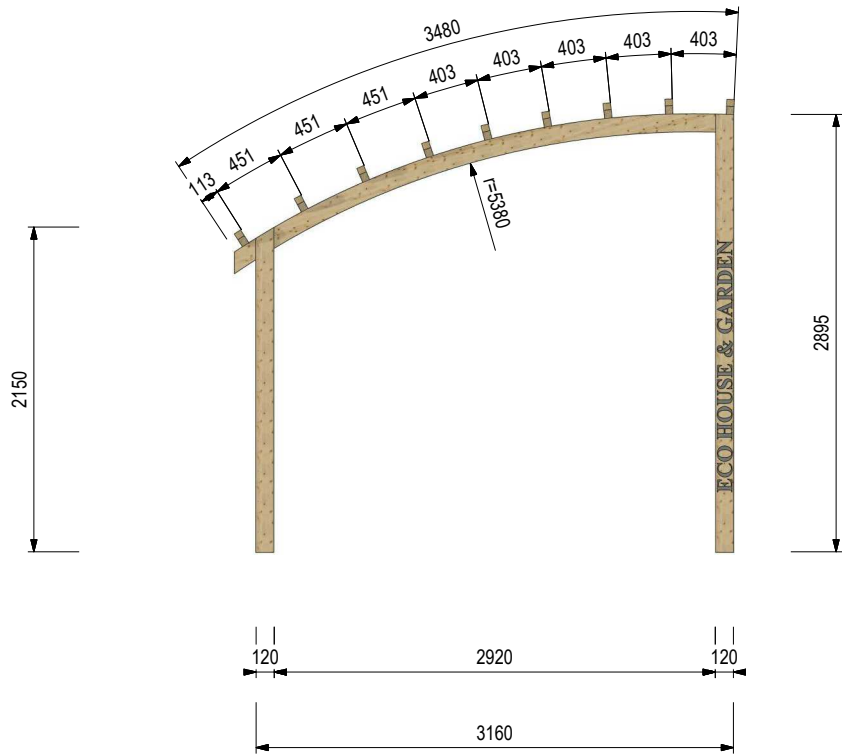

### Vedere axionometrică

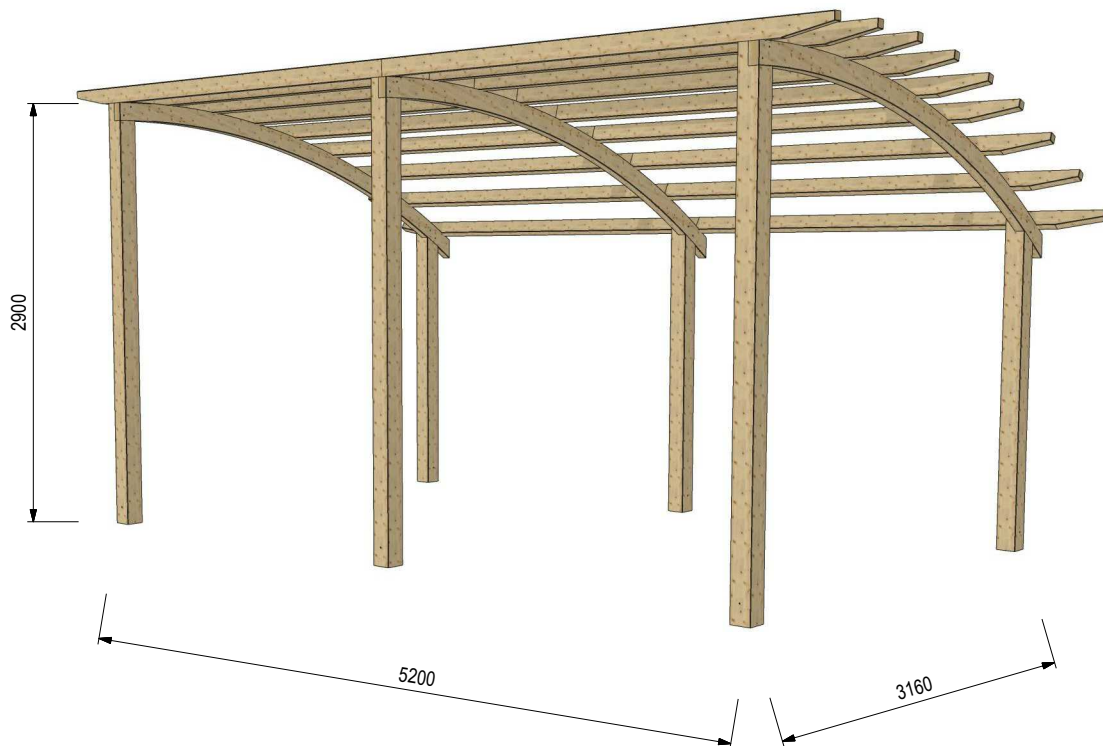

## Vedere longitudinală

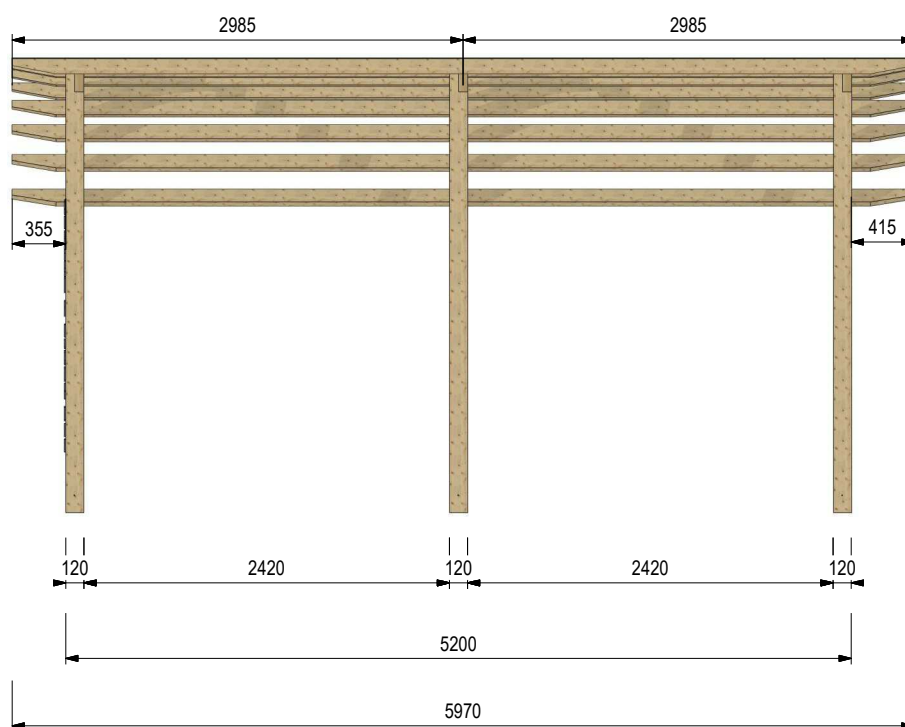

### LISTĂ MATERIALE LEON

Nr. Element	Cantitate [buc]	Nume [mm]
1	18	Traversă - 50x100x2985
2	3	Arc Leon - 55x120x3415
3	3	Stâlp - 120x120x2150
4	3	Stâlp - 120x120x2900

### LISTĂ FERONERIE LEON

Nr. Elemente	Cantitate [buc]	Nume [mm]
5	6	Papuc Metalic
6	18	Conexpand M10
7	18	Holz-Şurub Cap Hexagonal ø8x60
8	12	Holz-Şurub Cap Hexagonal ø8x100
9	36	Holz-Şurub Cap Hexagonal ø6x160

# Piese

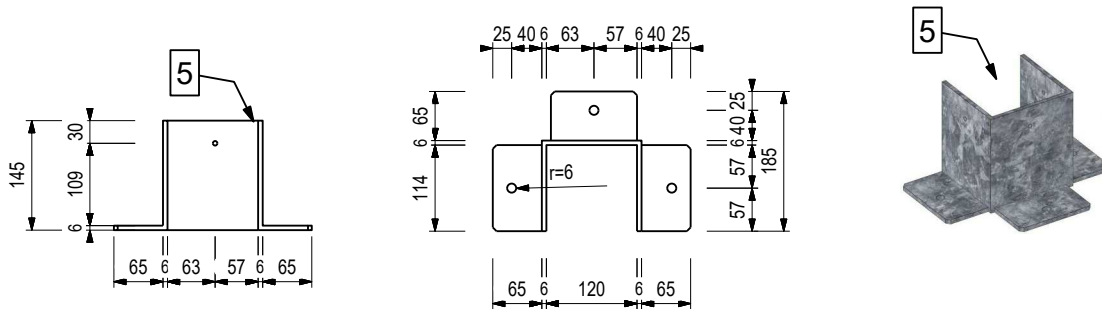
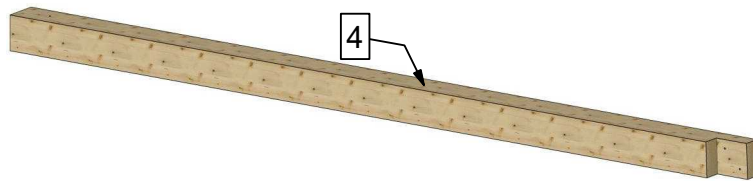
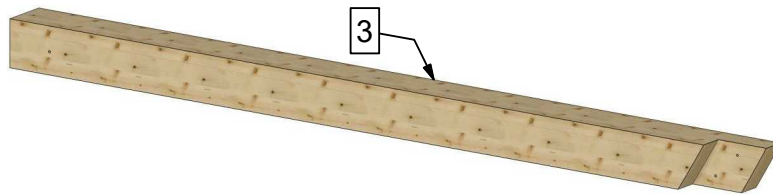
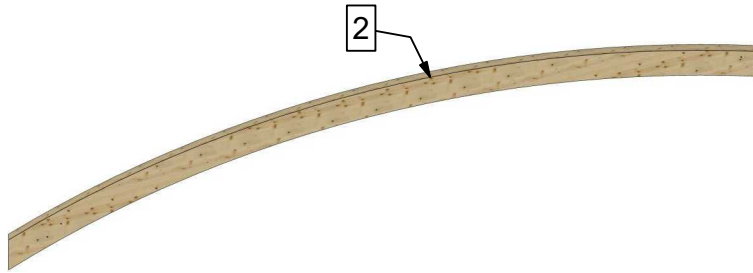
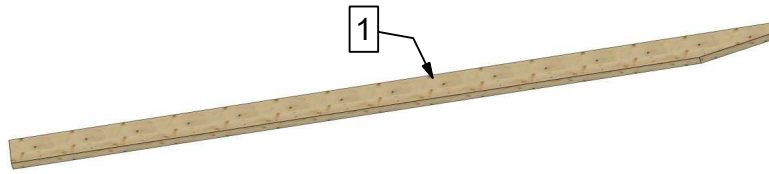

## Poziționare stâlpi în fundament cu papucul metalic

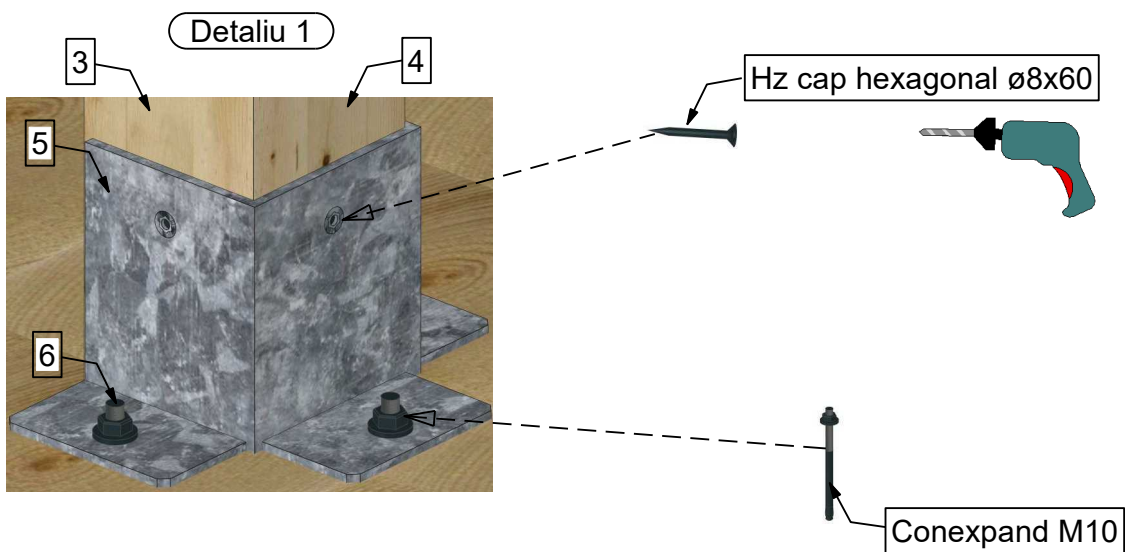
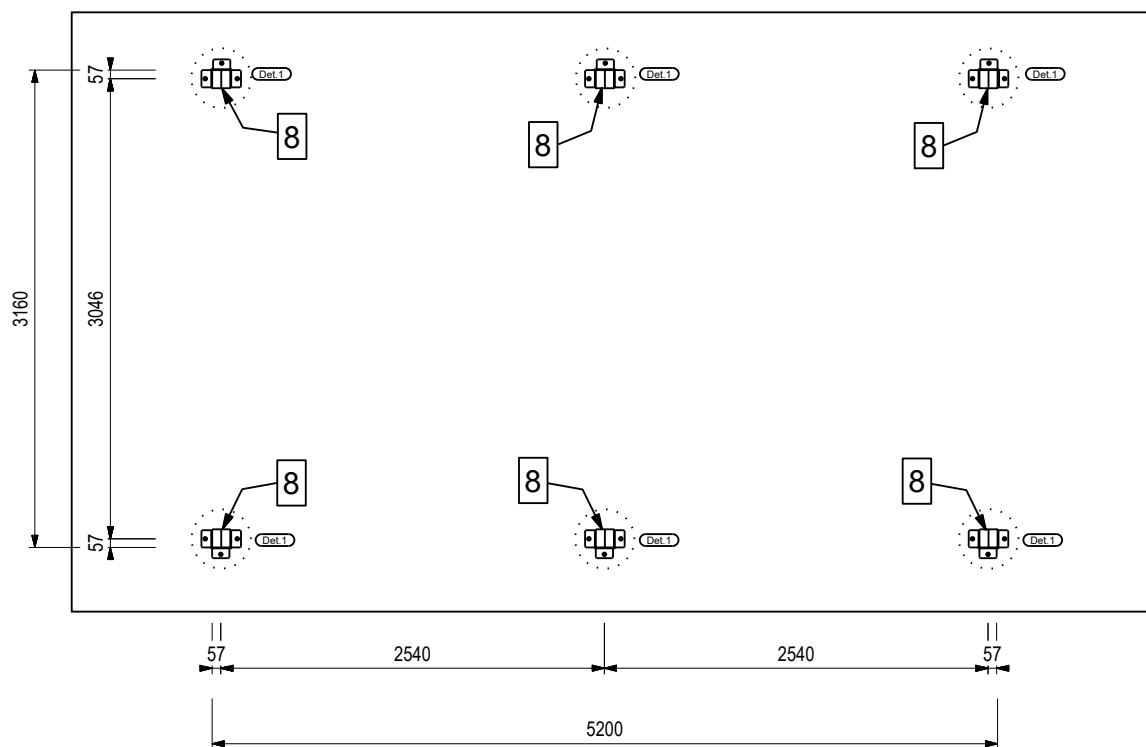

## Poziționare arc Leon în stâlpii 1 și 2



Detaliu 2



H<sub>z</sub> cap hexagonal ø8x100

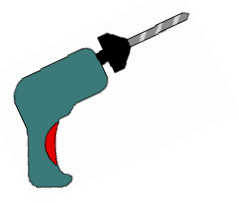

Detaliu 3

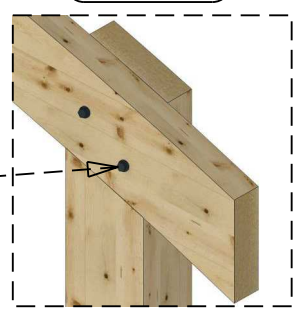

H<sub>z</sub> cap hexagonal ø8x100

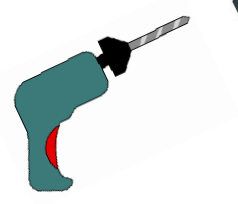

### Poziționare traversă

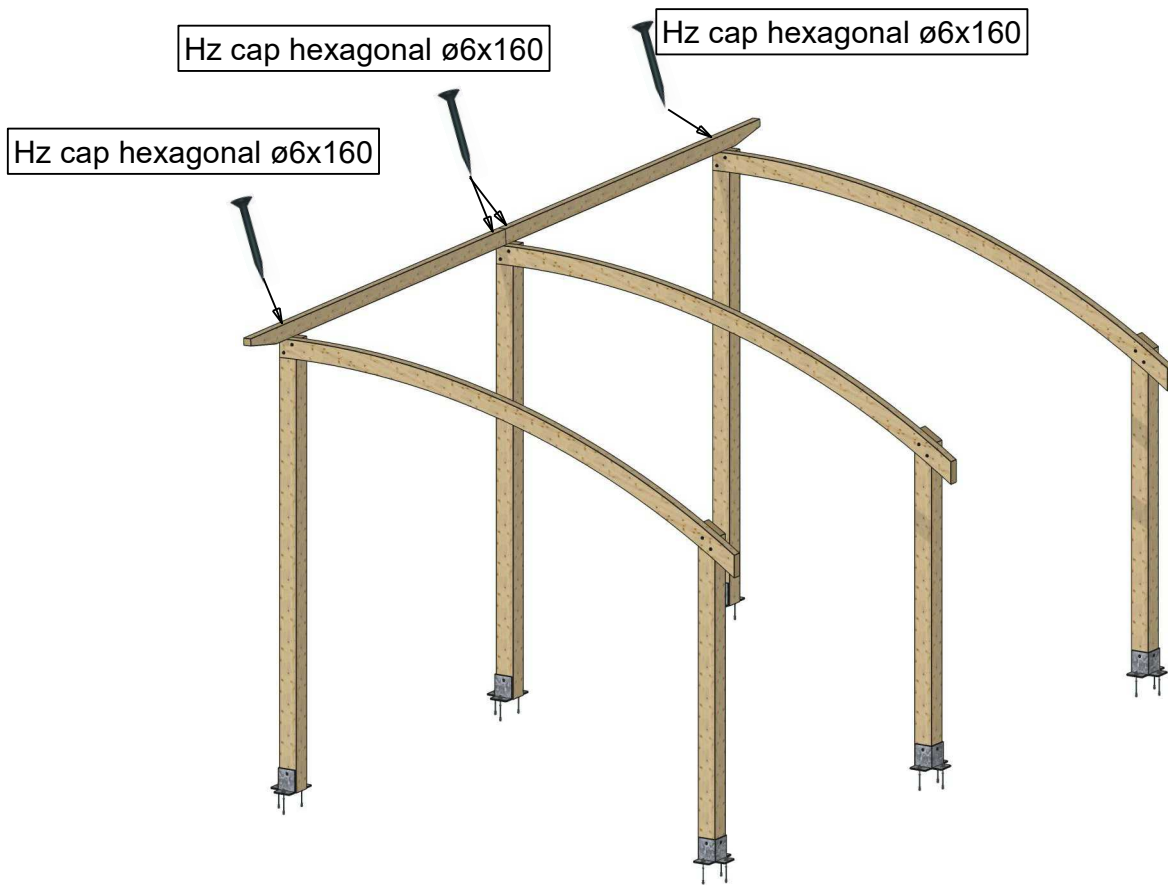

### Axionometrie Leon finală

