

Eco House & Garden Srl

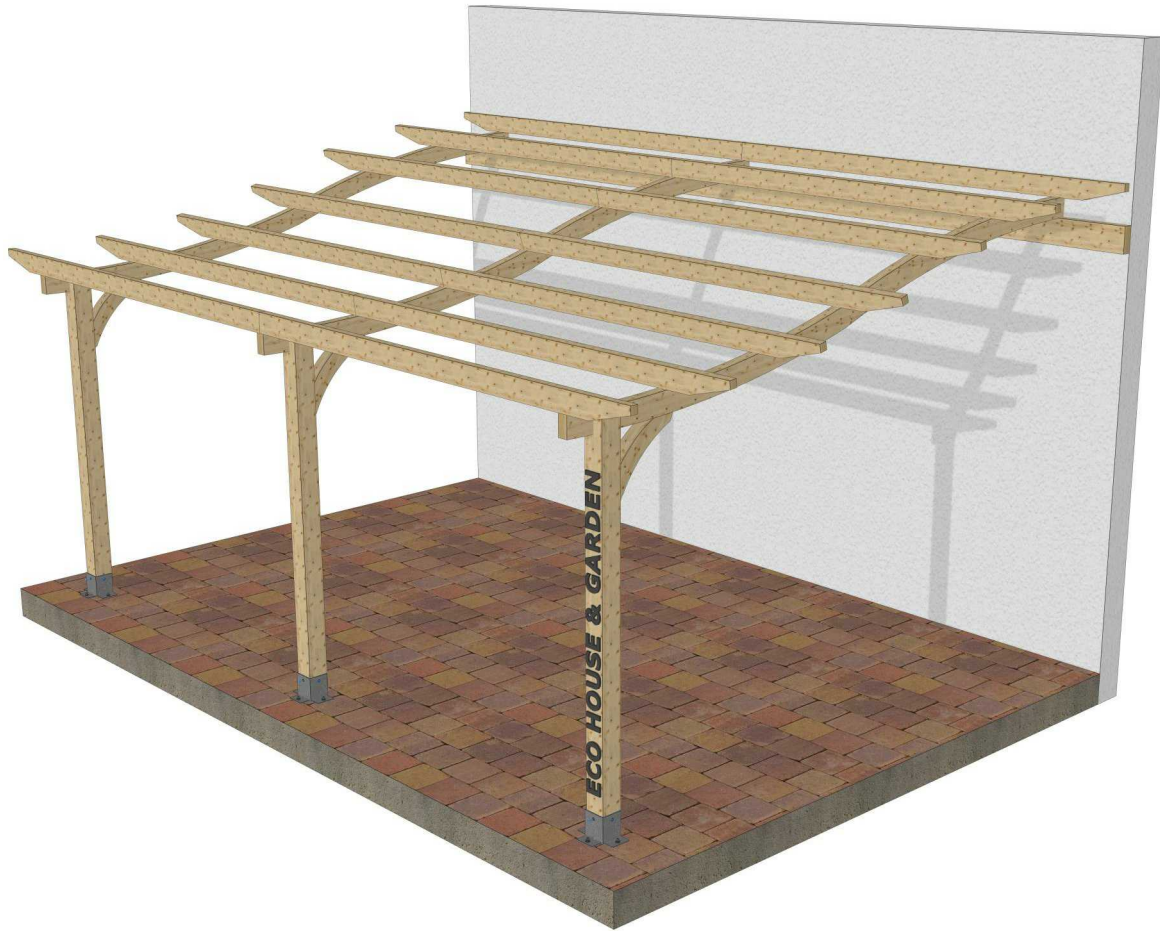

# ȚARAJ ONDA

L = 590 cm

W = 400 cm

H = 300 cm

## **Eco House & Garden Srl**

Str. Drumul Bercenarului, Nr. 2-4, Sector 4, CP .041116, București

Tel. +40 786 873 196

E-mail: [office@copertine-lemn.ro](mailto:office@copertine-lemn.ro) / [copertinelemn@gmail.com](mailto:copertinelemn@gmail.com)

[www.copertine-lemn.ro](http://www.copertine-lemn.ro)

[www.facebook.com/ecohouse.garden](https://www.facebook.com/ecohouse.garden)

## Vedere transversală

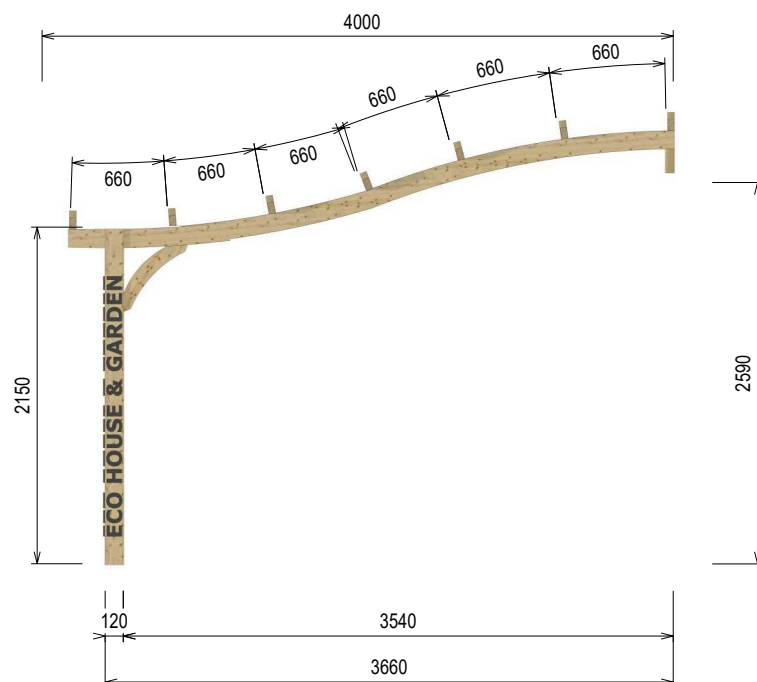

## Vedere axionometrică

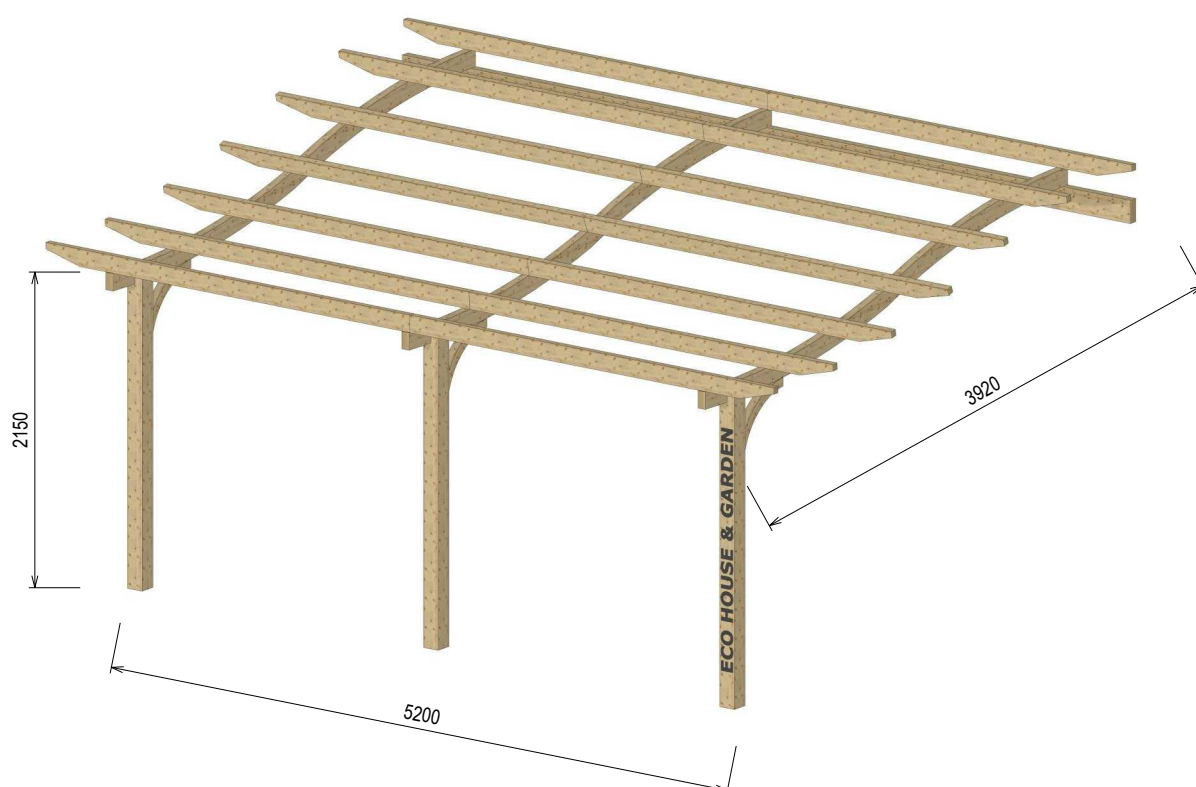

## Vedere longitudinală

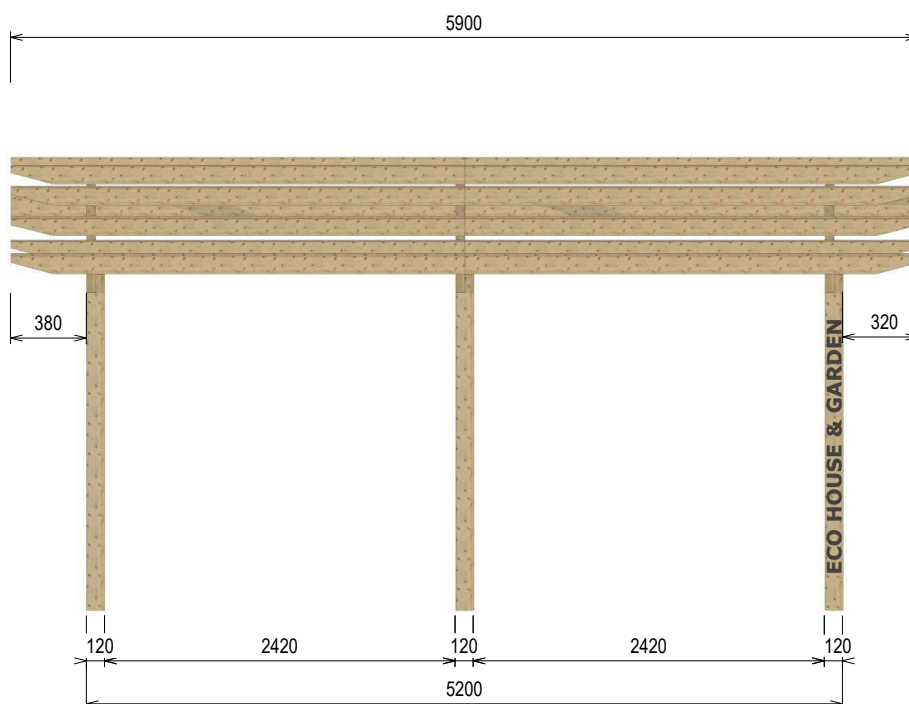

## LISTĂ MATERIALE COPERTINĂ ONDA

Nr. Element	Cantitate [buc]	Nume [mm]
1	3	Arc Onda - 60x120x4000
2	3	Stâlp - 120x120x2150
3	1	Grindă perete- 60x160x5900
4	14	Traversă - 45x120x2950
5	3	Contravântuire

## LISTĂ FERONERIE COPERTINĂ ONDA

Nr. Elemente	Cantitate [buc]	Nume [mm]
6	3	Papuc Metalic
7	9	Conexpand M10
8	9	Holz-Şurub Cap Hexagonal ø8x60
9	4	Conexpand ø12x250
10	6	Holz-Şurub Cap Hexagonal ø8x120
11	28	Holz-Şurub Cap Înecat ø6x160
12	6	Holz-Şurub Cap Înecat ø6x120
13	6	Holz-Şurub Cap Înecat ø8x240

# Piese

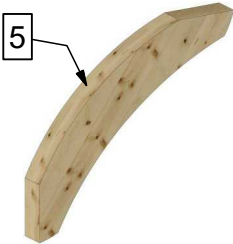
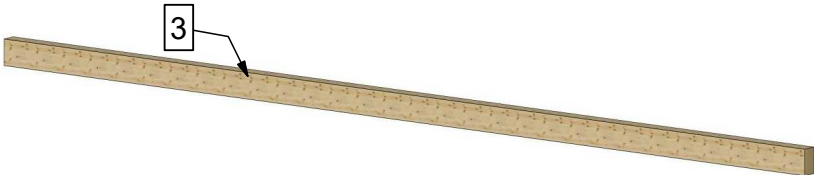
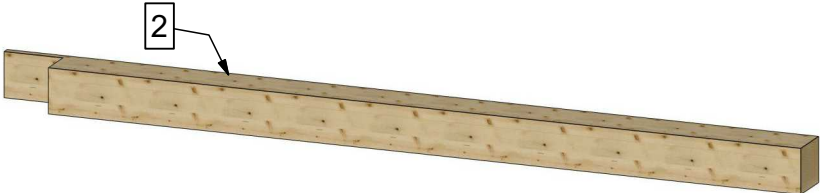
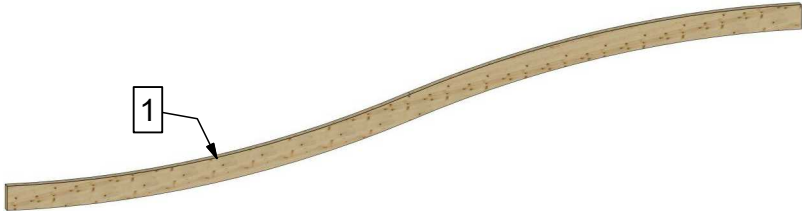

### Poziționare stâlpi în fundament cu papucul metalic

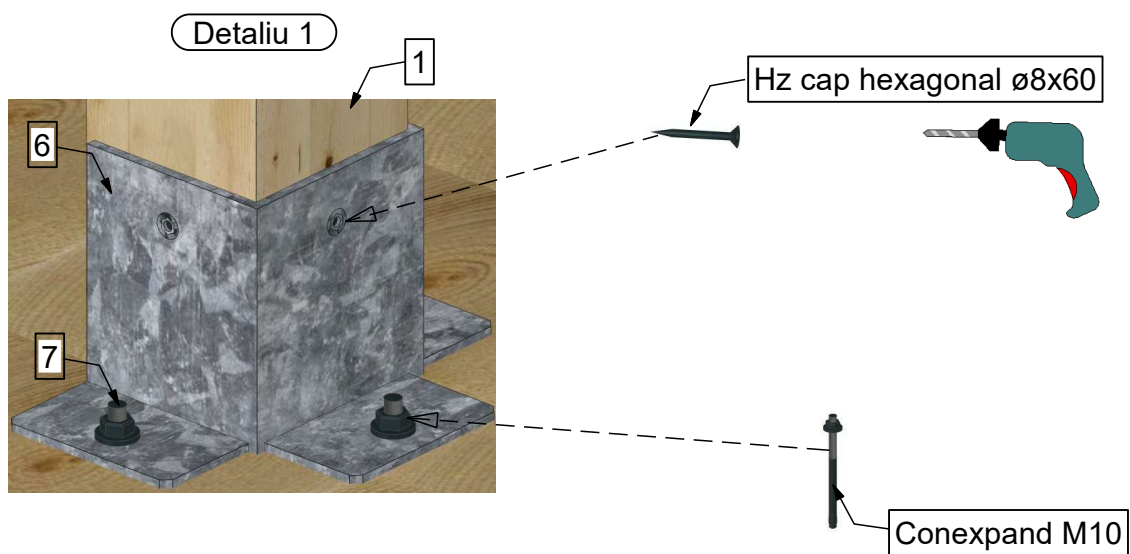
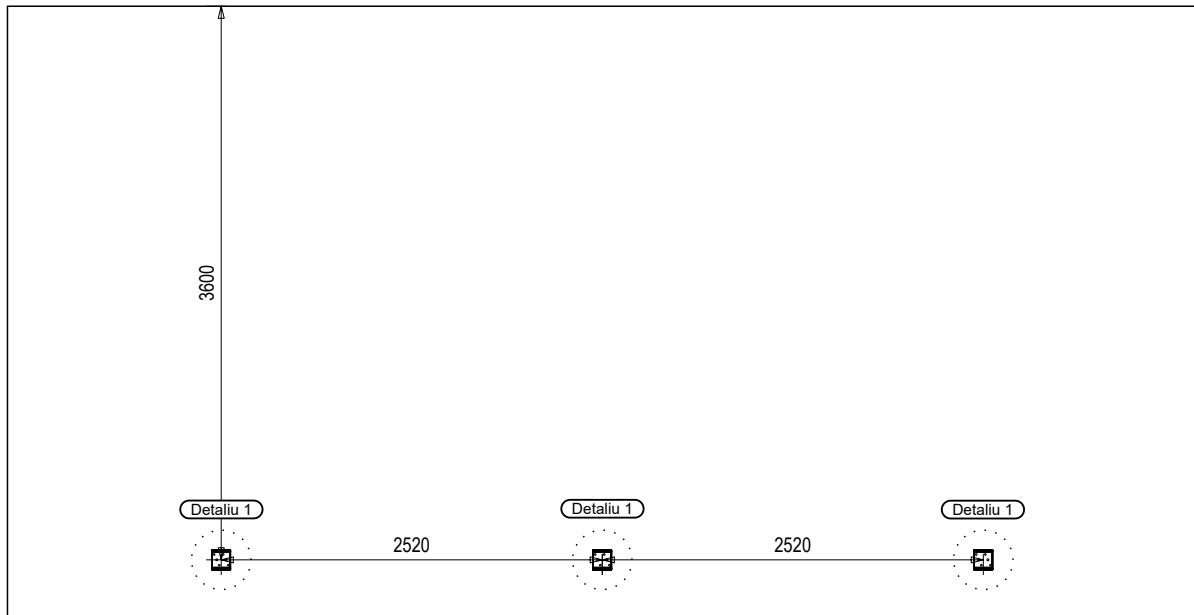

### Poziționare grindă pe perete

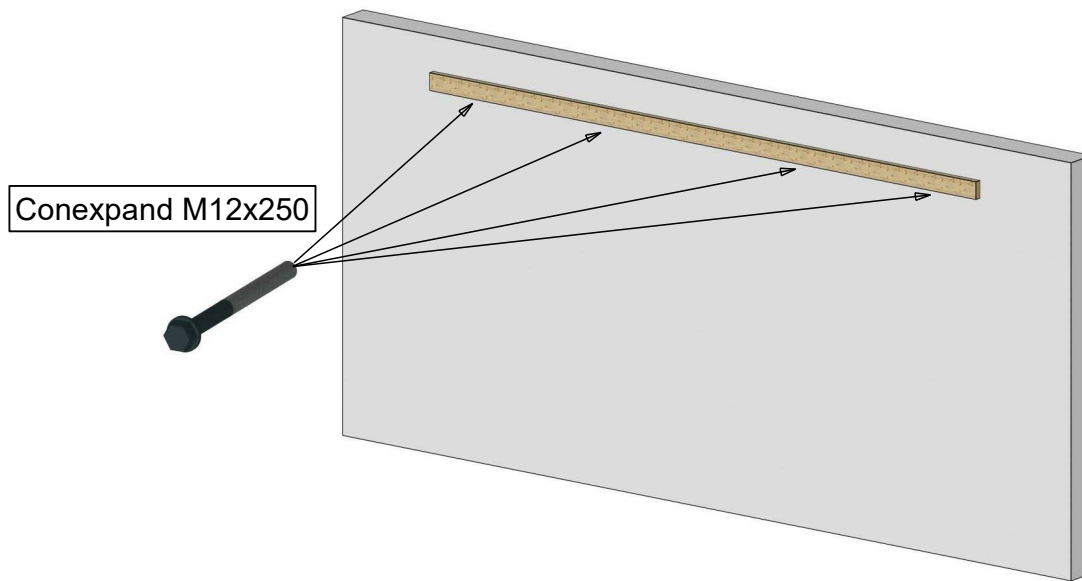

### Poziționare arce Onda și contravantuiri cu grinzile

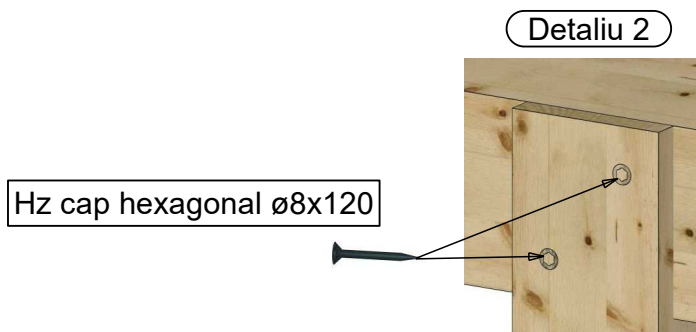
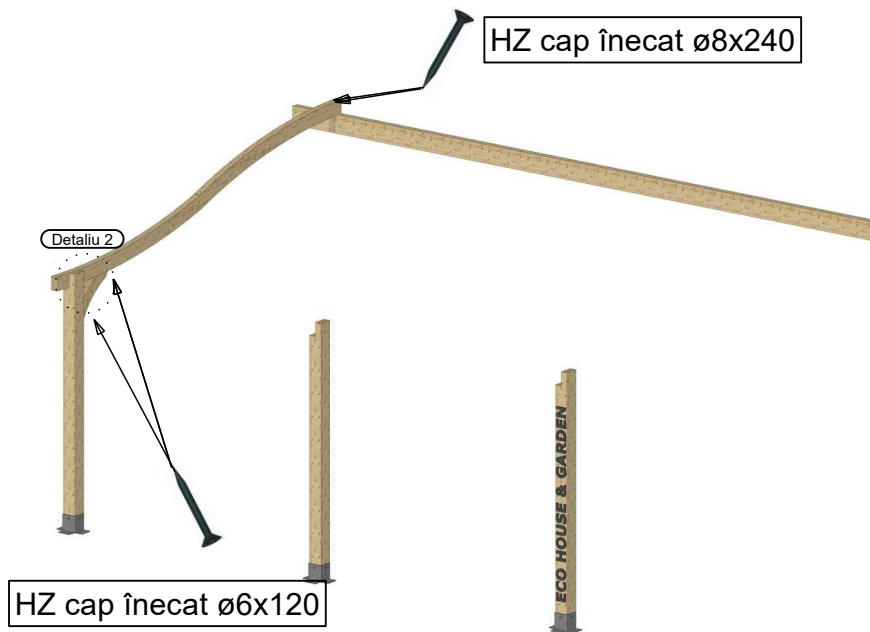

### Poziționare traverse

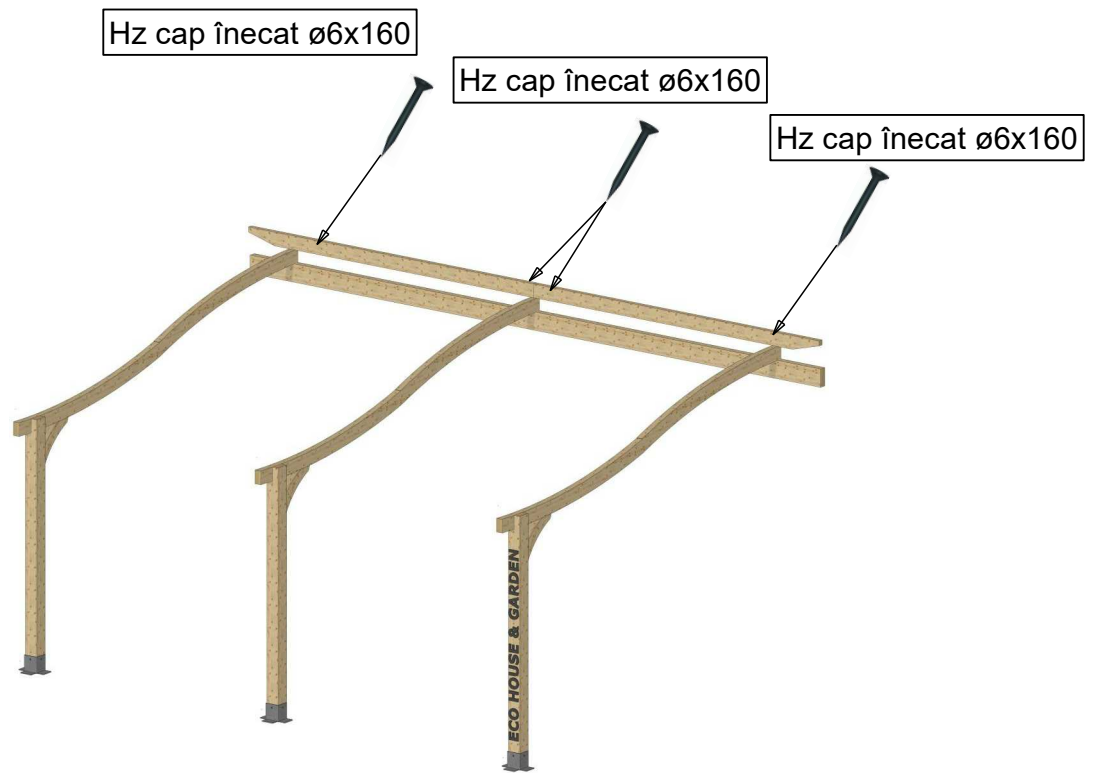

### Axonometrie finală

