

Eco House & Garden Srl

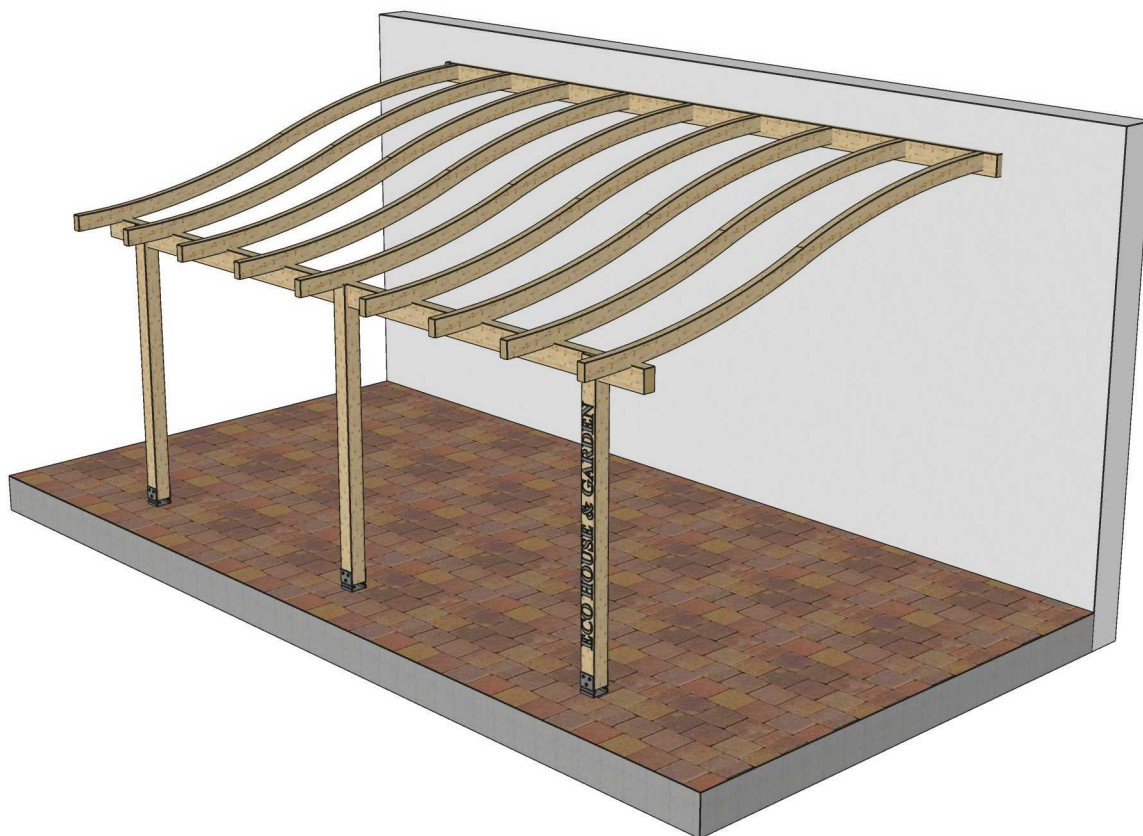

COPERTINA ONDA

L = 600 cm
W = 400 cm
H = 313 cm

Eco House & Garden Srl

Str. Drumul Bercenarului, Nr. 2-4, Sector 4, CP .041116, București
Tel. +40 786 873 196

E-mail: office@copertine-lemn.ro / copertinelemn@gmail.com

www.copertine-lemn.ro

www.facebook.com/ecohouse.garden

Vedere transversală

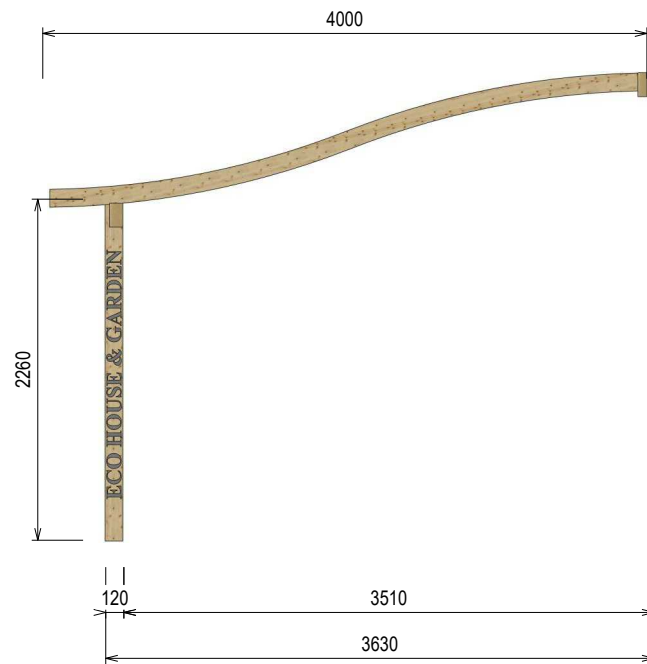

Vedere axionometrică

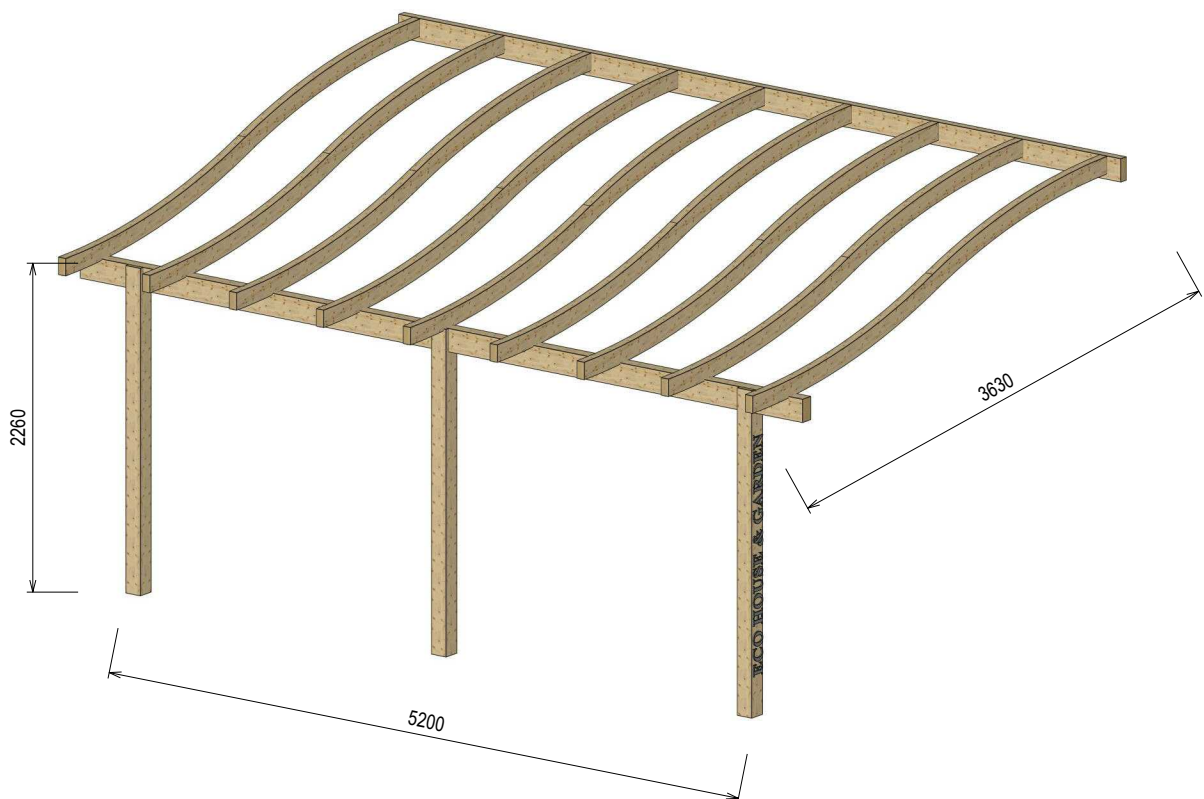

Vedere longitudinală

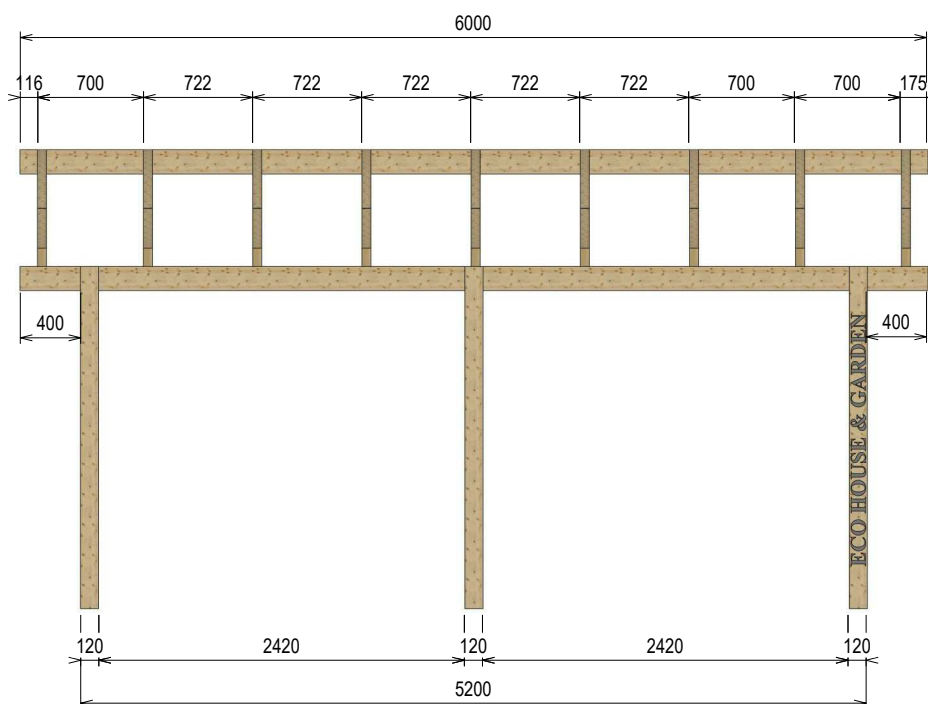

LISTĂ MATERIALE COPERTINĂ ONDA

Nr. Element	Cantitate [buc]	Nume [mm]
1	9	Arc Onda - 60x120x4000
2	3	Stâlp - 120x120x2260
3	1	Grindă perete- 60x160x6000
4	1	Grindă stâlpi - 90x160x6000

LISTĂ FERONERIE COPERTINĂ ONDA

Nr. Elemente	Cantitate [buc]	Nume [mm]
5	6	Șurub M8x100
6	12	Conexpand M10
6.1	12	Șaibă M10
6.2	9	Piuliță M10
7	3	Talpă metalică
8	9	Șurub M6x160
9	4	Conexpand M12x250
10	9	Prindere LOCKT 1880

Piese

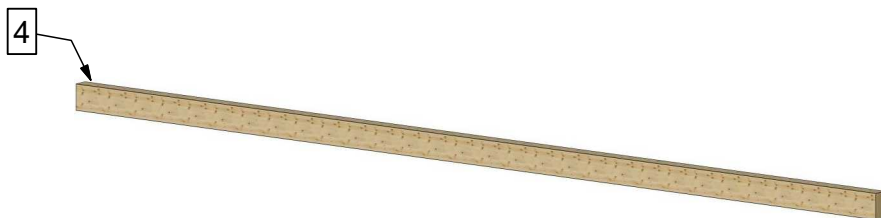
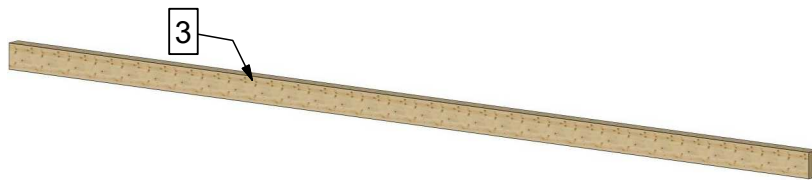
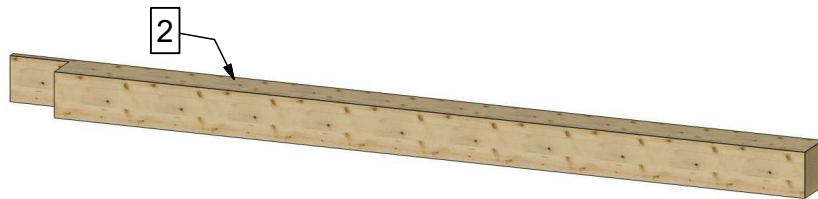
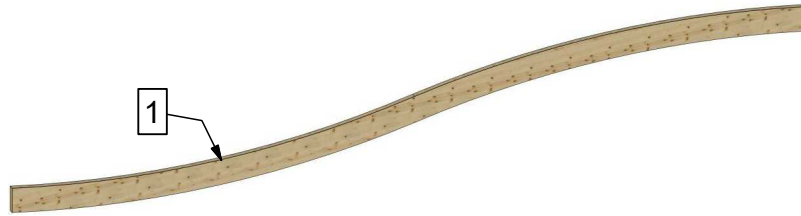

Poziționare stâlpi în fundament cu talpa metalică

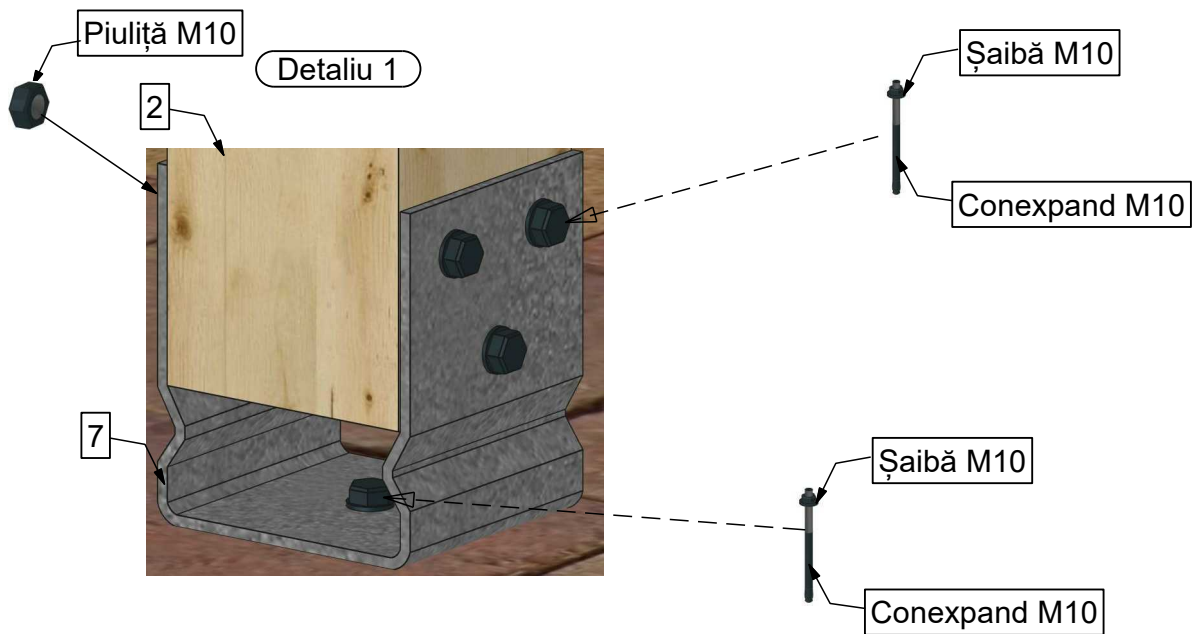
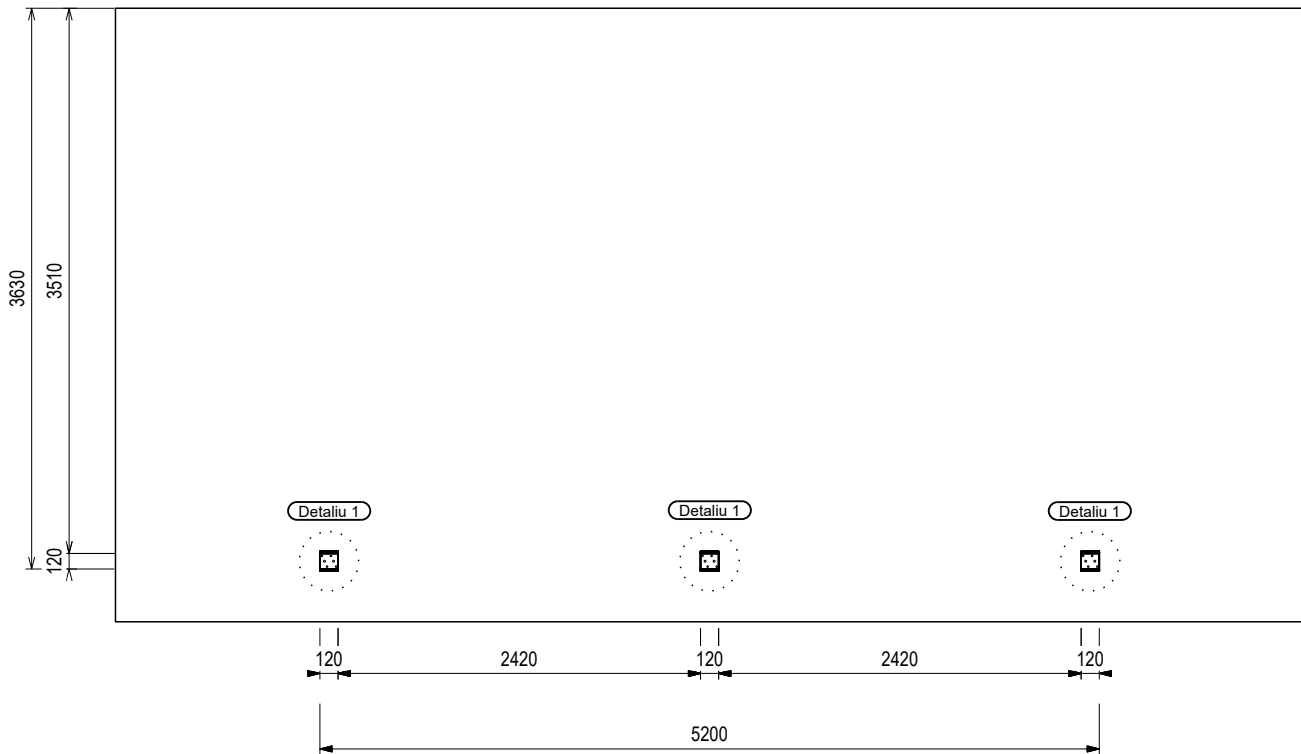

Poziționare grindă pe perete

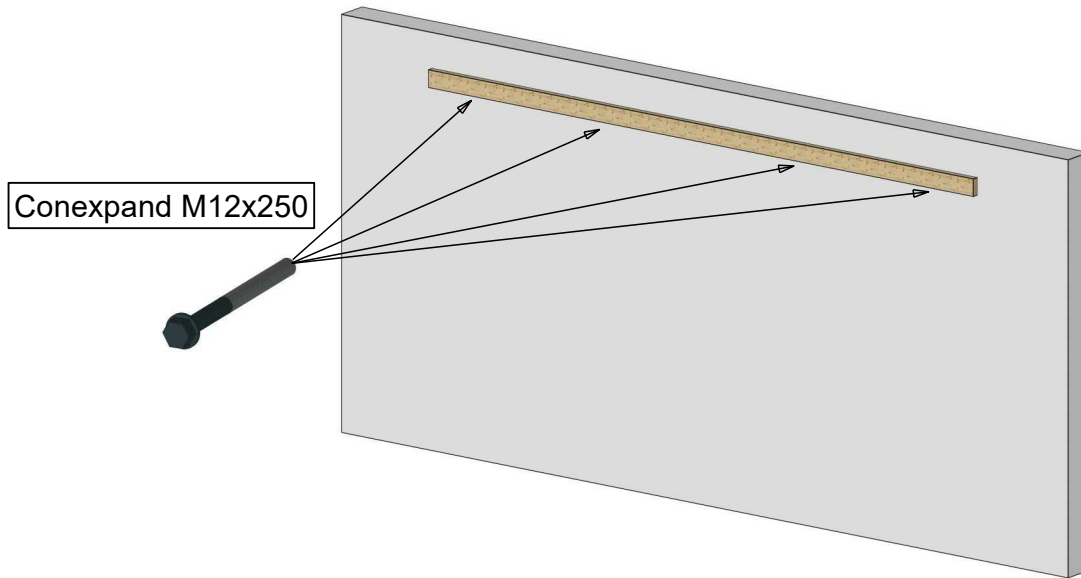

Poziționare grindă în stâlpi

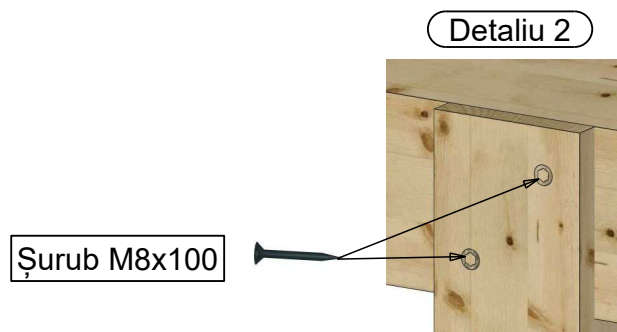

Poziționare arce Onda pe grinzi

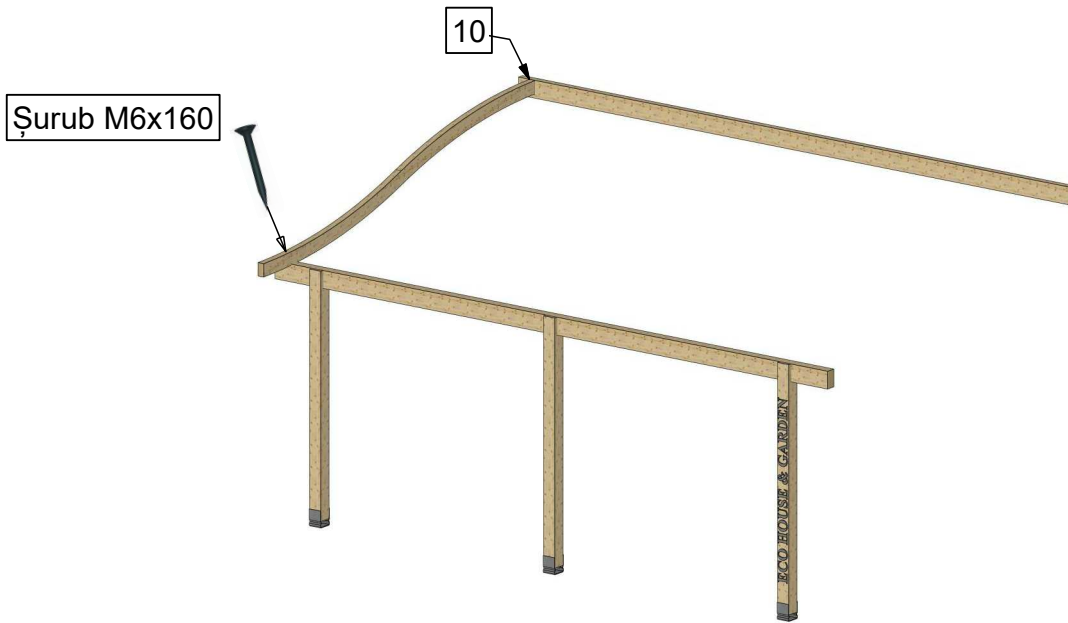

Axonometrie finală

